

Filters

Engine oil filter

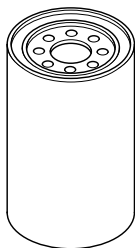

Fuel filter

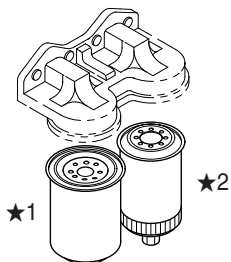

A/C Inner element (safety)

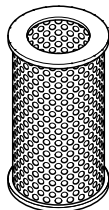

A/C Outer element (primary)

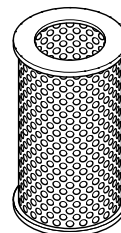

Coolant filter (corrosion resistor)

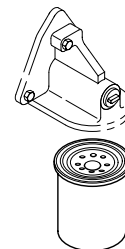

*Refer to page 8 for prefilter and fuel heater.

Hydraulic excavator

Model	Engine oil filter		Fuel filter		A/C Inner element		A/C Outer element		Corrosion resistor	
	Part no.	Qty	Part no.	Qty	Part no.	Qty	Part no.	Qty	Part no.	Qty
R16-9	XJAF-02697	1	XJAF-02784	1	XJAF-02699	1	XJAF-01587	1	-	
R27Z-9	XJAF-02697	1	XJAF-02784	1	11MH-20090	1	11MH-20100	1	-	
R35Z-7	XJAU-00756	1	XJAU-00817	1	11MH-20090	1	11MH-20100	1	-	
R35Z-7A	XJAU-00756	1	XJAU-00949	1	11MH-20090	1	11MH-20100	1	-	
R35Z-9	XJAU-00756	1	XJAU-00949	1	11MH-20090	1	11MH-20100	1	-	
R55-3	129150-35151	1	119000-55600	1	11S1-20120 #1254 11S1-20121 #1255	1	11S1-20110 #1254 11S1-20111 #1255	1	-	
R55-7	XJAU-00153	1	XJAU-00219	1	11M8-20110 #0409 11FK-20090 #0410	1	11M8-20120 #0409 11FK-20080 #0410	1	-	
R55-7A	XJAU-00890	1	XJAU-00949	1	11M8-20110	1	11M8-20120	1	-	
R55-9	119005-35151	1	XJAU-00949	1	11S7-40130	1	11S7-40120	1	-	
R80-7	XJAU-00498	1	XJAU-00575	1	11FK-20090	1	11FK-20080	1	-	
R80-7A	XJAU-00890	1	XJAU-00949	1	11M8-20110	1	11M8-20120	1	-	
R110-7	XJAF-00388	1	XJAF-00489	1	11E3-2006	1	E111-2009	1	-	
R110-7A	XJAF-02362	1	XJAF-02430	1	11N6-24530	1	11N6-24520	1	-	
R130LC	11E1-70110	1	11E1-70010* ¹ 11E1-70210* ²	1	11E3-2006	1	E111-2009	1	-	
R130LC-3	11E1-70110	1	11E1-70010* ¹ 11E1-70210* ²	1	11E3-2006	1	E111-2009	1	-	
R140LC-7	3908616 #1000	1	11E1-70010* ¹ #1000 11E1-70210* ² #1000	1	11EM-21051	1	11EM-21041	1	-	
R140LC-7* ⁶	3934429 #1494 11N4-70110 #1495	1	11N4-70210 #1494 11E1-70010* ¹ #1495 11E1-70210* ² #1495	1	11EM-21051 #2607 11N6-24530 #2608 11E3-2006* ⁷ #0094	1	11EM-21041 #2607 11N6-24520 #2608 E111-2009* ⁷ #0094	1	-	
R140LC-7A	XJAF-02362	1	XJAF-02430	1	11N6-24530	1	11N6-24520	1	-	
R145CR-9	XJAF-02362	1	XJAF-02430	1	11N4-29140	1	11N4-29110	1	-	
R140LC-9	XJAF-02362	1	XJAF-02430	1	11N6-27030	1	11N6-27040	1	-	
R160LC-3	11E1-70110	1	11E1-70010* ¹ 11E1-70210* ²	1	E211-2104	1	E211-2103	1	-	
R160LC-7	32B40-10100 #0955 32B40-20100 #0956	1	34362-00101	1	11EM-21051 #0746 11N6-24530 #0747	1	11EM-21041 #0746 11N6-24520 #0747	1	-	
R160LC-7A	XJAF-02362	1	XJAF-02430	1	11N6-24530	1	11N6-24520	1	-	
R160LC-9	XJAF-02362	1	XJAF-02430	1	11N6-27030	1	11N6-27040	1	-	
R180LC-3	11E1-70140	1	11E1-70010* ¹ 11E1-70210* ²	1	E211-2104	1	E211-2103	1	-	
R180LC-7	32B40-10100 #0466 32B40-20100 #0467	1	34362-00101	1	11EM-21051 #0352 11N6-24530 #0353	1	11EM-21041 #0352 11N6-24520 #0353	1	-	
R180LC-7A	XJAF-02362	1	XJAF-02430	1	11N6-24530	1	11N6-24520	1	-	
R180LC-9	XJAF-02362	1	XJAF-02430	1	11N6-27030	1	11N6-27040	1	-	
R200LC	11E1-70120	1	11E1-70010* ¹ 11E1-70210* ²	1	E211-2104	1	E211-2103	1	-	
R210LC-3 R210LC-3LL	11E1-70140	1	11E1-70010* ¹ 11E1-70210* ²	1	E211-2104	1	E211-2103	1	-	
33HDLL	11E1-70140	1	11E1-70010* ¹ 11E1-70210* ²	1	E211-2104	1	E211-2103	1	-	
R210LC-7	11E1-70140	1	11E1-70010* ¹ 11E1-70210* ²	1	11EM-21051	1	11EM-21041	1	-	

*¹Fuel filter *²Fuel filter with water separator

*³Hyundai engine

*⁴Bypass filter

*⁵Low emission

*⁶TIER II (R140LC-7 : #1001~, R210LC-7 : #1001~)

*⁷Australia & New Zealand

Filters

Engine oil filter

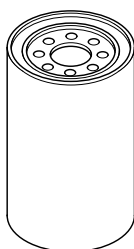

Fuel filter

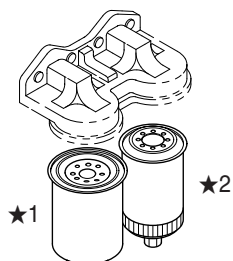

A/C Inner element (safety)

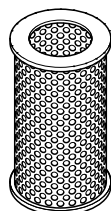

A/C Outer element (primary)

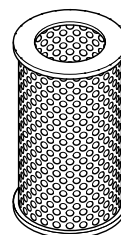

Coolant filter (corrosion resistor)

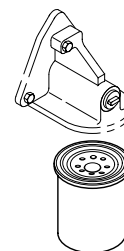

*Refer to page 8 for prefilter and fuel heater.

Hydraulic excavator

Model	Engine oil filter		Fuel filter		A/C Inner element		A/C Outer element		Corrosion resistor	
	Part no.	Qty	Part no.	Qty	Part no.	Qty	Part no.	Qty	Part no.	Qty
R210LC-7*6	11E1-70140	1	11E1-70010 11E1-70010*1 11E1-70210*2	1	11EM-21051 11N6-24530	1	11EM-21041 11N6-24520	1	-	
R210LC-7A	11N8-70110	1	11LC-70010	1	11N6-24530	1	11N6-24520	1	-	
R210LC-7H	26316-93000	1	31940-93001	1	11EM-21051 11N6-24530	1	11EM-21041 11N6-24520	1	-	
R210LC-9	11N8-70110	1	11LG-70010	1	11N6-27030	1	11N6-27040	1	-	
R210NLC-7	11E1-70140	1	11E1-70010 11E1-70010*1 11E1-70210*2	1	11EM-21051 11N6-24530	1	11EM-21041 11N6-24520	1	-	
R210NLC-7A	11N8-70110	1	11LC-70010	1	11N6-24530	1	11N6-24520	1	-	
R210NLC-9	11N8-70110	1	11LG-70010	1	11N6-27030	1	11N6-27040	1	-	
R235LCR-9	11N8-70110	1	11LG-70010	1	11N6-27030	1	11N6-27040	1	-	
R250LC-3	11E1-70140	1	11E1-70010*1 11E1-70210*2	1	11EN-22080	1	11EN-22070	1	-	
R250LC-7	11E1-70140	1	11E1-70010 11E1-70010*1 11E1-70210*2	1	11EM-21051 11N6-24530	1	11EM-21041 11N6-24520	1	-	
R250LC-7A	11N8-70110	1	11LG-70010	1	11N6-24530	1	11N6-24520	1	-	
R250LC-9	11N8-70110	1	11LG-70010	1	11N6-27030	1	11N6-27040	1	-	
R280LC	11E1-70130	1	11E1-70010*1 11E1-70210*2	1	E211-2104	1	E211-2103	1	11E1-70310	1
R290LC	11E1-70130	1	11E1-70010*1 11E1-70210*2	1	E211-2104	1	E211-2103	1	11E1-70310	1
R290LC-3 R290LC-3LL/RB	11E1-70130	1	11E1-70010*1 11E1-70210*2	1	E211-2104	1	E211-2103	1	11E1-70310	1
42HDL 39HDL	11E1-70130	1	11E1-70010*1 11E1-70210*2	1	E211-2104	1	E211-2103	1	11E1-70310	1
R290LC-7	11E1-70130	1	11E1-70010*1 11E1-70210*2 11N8-70010	1	11EM-21051 11N6-24530	1	11EM-21041 11N6-24520	1	11E1-70310	1
R290LC-7*6	11N8-70110	1	11N8-70010	1	11EM-21051 11N6-24530	1	11EM-21041 11N6-24520	1	-	
R290LC-7A	11N8-70110	1	11LG-70010	1	11EM-21051 11N6-24530	1	11EM-21041 11N6-24520	1	-	
R290LC-7H	26452-72001	1	31945-72001	1	11N8-22150	1	11N8-22140	1	-	
R290LC-9	11N8-70110	1	11LG-70010	1	11Q8-20310	1	11Q8-20320	1	-	
R305LC-7	11NA-70110	1	11E1-70010*1 11E1-70210*2	1	11N8-22150	1	11N8-22140	1	11E1-70310	
R320LC	11E1-70130	1	11E1-70240	1	11EH-20030	1	11E5-2008	1	11E1-70320	1
R320LC-3	11E1-70130	1	11E1-70010*1 11E1-70210*2	1	11EH-20030	1	11E5-2008	1	11E1-70310	1
R320LC-7	11NA-70110	1	11E1-70010*1 11E1-70210*2	1	11N8-22150	1	11N8-22140	1	11NA-70210	1
R320LC-7A	11NA-70110	1	11LB-70020	1	11N8-22150	1	11N8-22140	1	11NA-70210	1
R320LC-9	11NA-70110	1	11LB-70020	1	11Q8-20310	1	11Q8-20320	1	11NA-70210	1
R360LC-3	11E1-70130	1	11E1-70240	1	11EH-20030	1	11E5-2008	1	11E1-70320	1
R360LC-7	11NA-70110	1	11NA-70010*1 3800394*2	1	11N8-22150	1	11N8-22140	1	11NA-70210	1

*1Fuel filter

*2Fuel filter with water separator

*6TIER II (R290LC-7 : #0112-)

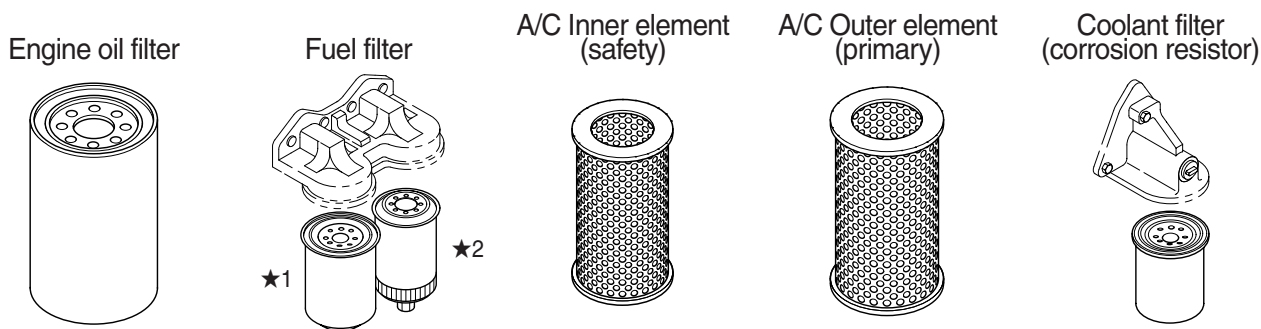

*Refer to page 8 for prefilter and fuel heater.

Hydraulic excavator

Model	Engine oil filter		Fuel filter		A/C Inner element		A/C Outer element		Corrosion resistor	
	Part no.	Qty	Part no.	Qty	Part no.	Qty	Part no.	Qty	Part no.	Qty
R360LC-7A	11NA-70110	1	11LB-70020	1	11NB-20130	1	11NB-20120	1	11NA-70210	1
R380LC-9	11NA-70110	1	11LB-70020	1	11Q8-20120	1	11Q8-20130	1	11NA-70210	1
R450LC	600-211-1230	1	600-311-8282*1	1	600-181-1600 11E7-0081	1	600-181-1660 11E7-0082	1	600-411-1570	1
R450LC-3	11E1-70130	1	11E1-70240 11E1-70220*5*1 11E1-70240*5*2	1 1 1	11L1-2004*5 14L1-01570*5	1	11L1-2003*5 11L1-20031*5 14L1-01560*5	1	11E1-70320	1
R450LC-7	11NB-70110	1	11NB-70010	1	11NB-20130	1	11NB-20120	1	11NB-70210	1
R450LC-7A	11NB-70110	1	11NB-70010	2	11NB-20130	1	11NB-20120	1	11NB-70210	1
R480LC-9	11NB-70110	1	11NB-70010	2	11Q8-20120	1	11Q8-20130	1	11NB-70210	1
R500LC-7	11NB-70110	1	11NB-70010	2	11NB-20130	1	11NB-20120	1	11NB-70210	1
R500LC-7A	11NB-70110	1	11NB-70010	2	11NB-20130	1	11NB-20120	1	11NB-70210	1
R520LC-9	11NB-70110	1	11NB-70010	2	11Q8-20120	1	11Q8-20130	1	11NB-70210	1
R210LC-3*3	26300-93000	1	31950-93000	1	E211-2104	1	E211-2103	1	-	
R290LC-3*3	26452-72000 26316-83000*4	1	31945-72000	1	E211-2104	1	E211-2103	1	-	
R320LC-3*3	26452-72000 26316-83000*4	1	31945-72000	1	11EH-20030	1	11E5-2008	1	-	
R360LC-3*3	26452-72000 26316-83000*4	1	31945-72000	1	11EH-20030	1	11E5-2008	1	-	
R800LC-7A	11ND-70110	1	11ND-70010	1	11ND-20230	1	11ND-20240	1	11ND-70211	1

*1Fuel filter

*2Fuel filter with water separator

*3Hyundai engine

*4Bypass filter

*5Low emission

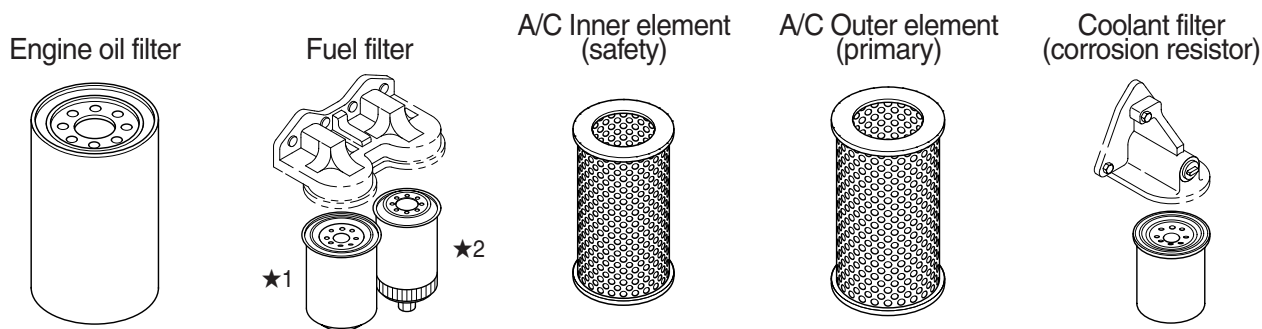

*Refer to page 8 for prefilter and fuel heater.

Hydraulic excavator

Model	Engine oil filter		Fuel filter		A/C Inner element		A/C Outer element		Corrosion resistor	
	Part no.	Qty	Part no.	Qty	Part no.	Qty	Part no.	Qty	Part no.	Qty
R55W-3	129150-35151	1	119000-55600	1	11S1-20120 -#0179 11S1-20121 #0180-	1	11S1-20110 -#0179 11S1-20111 #0180-	1	-	
R55W-7	XJAU-00153	1	XJAU-00219	1	11M8-20110 -#0028 11FK-20090 #0029-	1	11M8-20120 -#0028 11FK-20080 #0029-	1	-	
R55W-7A	XJAU-00890	1	XJAU-00949	1	11M8-20110	1	11M8-20120	1	-	
R55W-9	119005-35151	1	XJAU-00949	1	11S7-40130	1	11S7-40120	1	-	
R95W-3	32A40-00100	1	34462-00300	1	11S1-20120	1	11S1-20110	1	-	
R120W	11E1-70110	1	11E1-70010* ¹ 11E1-70210* ²	1 1	11E3-2006	1	E111-2009	1	-	
R130W	11E1-70110	1	11E1-70010* ¹ 11E1-70210* ²	1 1	11E3-2006	1	E111-2009	1	-	
R130W-3	11E1-70110	1	11E1-70010* ¹ 11E1-70210* ²	1 1	E211-2104	1	E211-2103	1	-	
R140W-7	3934429 -#0071 11N4-70110 #0072-	1	11N4-70210 -#0071 11E1-70010* ¹ * ⁶ #0072- 11E1-70210* ² * ⁶ #0072-	1	11EM-21051 -#0452 11N6-24530 #0453- 11E3-2006* ⁷	1	11EM-21041 -#0452 11N6-24520 #0453- E111-2009* ⁷	1	-	
R140W-7A	XJAF-02362	1	XJAF-02430	1	11N6-24530	1	11N6-24520	1	-	
R140W-9	11N8-70110	1	11LG-70010	1	11N6-27030	1	11N6-27040	1	-	
R170W-3	11E1-70110	1	11E1-70010* ¹ 11E1-70210* ²	1 1	E211-2104	1	E211-2103	1	-	
R170W-7	32B40-10100 -#1479 32B40-20100 #1480-	1	34362-00101	1	11EM-21051 -#0783 11N6-24530 #0784-	1	11EM-21041 -#0783 11N6-24520 #0784-	1	-	
R170W-7A	XJAF-02362	1	XJAF-02430	1	11N6-24530	1	11N6-24520	1	-	
R170W-9	11N8-70110	1	11LG-70010	1	11N6-27030	1	11N6-27040	1	-	
R200W	11E1-70110	1	11E1-70010* ¹ 11E1-70210* ²	1 1	E211-2104	1	E211-2103	1	-	
R200W-3	11E1-70110	1	11E1-70010* ¹ 11E1-70210* ²	1 1	11EM-21051	1	11EM-21041	1	-	
R200W-7	11E1-70140	1	11E1-70010 -#0193 11E1-70010* ¹ #0194- 11E1-70210* ² #0194-	1	11EM-21051 -#0882 11N6-24530 #0883-	1	11EM-21041 -#0882 11N6-24520 #0883-	1	-	
R200W-7A	11N8-70110	1	11LC-70010	1	11N6-24530	1	11N6-24520	1	-	
R210W-9	11N8-70110	1	11LG-70010	1	11N6-27030	1	11N6-27040	1	-	

*¹Fuel filter

*²Fuel filter with water separator

*⁶TIER II (R140W-7 : #0072~)

*⁷Australia & New Zealand

Engine oil filter

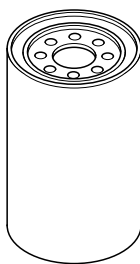

Fuel filter

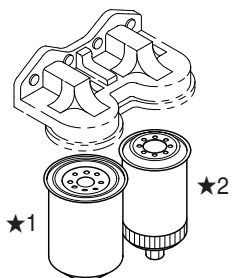

A/C Inner element (safety)

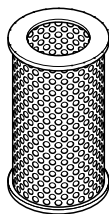

A/C Outer element (primary)

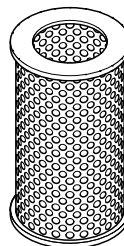

Coolant filter (corrosion resistor)

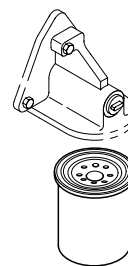

*Refer to page 8 for prefilter and fuel heater.

Wheel loader

Model	Engine oil filter		Fuel filter		A/C Inner element		A/C Outer element		Corrosion resistor	
	Part no.	Qty	Part no.	Qty	Part no.	Qty	Part no.	Qty	Part no.	Qty
HL17	11E1-70110	1	11E1-70010* ¹ 11E1-70210* ²	1 1	11L4-0079	1	11L4-0078	1	-	
HL25	11E1-70130	1	11E1-70010* ¹ 11E1-70210* ²	1 1	11L4-0079	1	11L4-0078	1	11E1-70310	1
HL35	11E1-70130	1	11E1-70240	1	11L1-2004	1	11L1-2003	1	11E1-70320	1
HL720-3	01174418	1	01180596* ¹ 11L8-20180* ²	1 1	01180871	1	01319258	1	-	
HL730-3 HL730TM-3	01174418 -#1000 11E1-70110 #1001-	1	01180596* ¹ -#1000 11E1-70010* ¹ #1001- 11L8-20180* ² -#1000 11E1-70210* ² #1001-	1 1 1 1	01180871 -#1000 E211-2103 #1001-	1	01319258 -#1000 E211-2104 #1001-	1	-	
HL730-7 HL730TM-7	11N4-70110	1	11N4-70210	1	11EM-21051	1	11EM-21041	1	-	
HL730-7A HL730TM-7A	11N8-70110	1	11LG-70010	1	11EM-21051	1	11EM-21041	1	-	
HL730-9 HL730TM-9	11N8-70110	1	11LG-70010	1	11N6-27030	1	11N6-27040	1		
HL740-3 HL740TM-3	11E1-70110 -#0847 3932217 #0848-	1	11E1-70010* ¹ 11E1-70210* ²	1 1	E211-2104	1	E211-2103	1	-	
HL740-7 HL740TM-7	11E1-70140	1	11LD-70010	1	11EM-21051	1	11EM-21041	1	-	
HL740-7A HL740TM-7A	11N8-70110	1	11LG-70010	1	11N8-22150	1	11N8-22140	1	-	
HL740-9 HL740TM-9	11N8-70110	1	11LG-70010	1	11Q8-20310	1	11Q8-20320	1	-	
HL750 HL750TM	11E1-70130	1	11E1-70010* ¹ 11E1-70210* ²	1 1	11L4-0079	1	11L4-0078	1	-	
HL757-7 HL757TM-7	11E1-70140	1	11LD-70010	1	11EM-21051	1	11EM-21041	1	-	
HL757-7A HL757TM-7A	11N8-70110	1	11LG-70010	1	11N8-22150	1	11N8-22140	1	-	
HL757-9 HL757TM-9	11N8-70110	1	11LG-70010	1	11Q8-20310	1	11Q8-20320	1		
HL760	11E1-70130	1	11E1-70010* ¹ 11E1-70210* ²	1 1	11L4-0079 11L1-2004* ⁵	1 1	11L4-0078 11L1-20031* ⁵	1 1	11E1-70310	1
HL760-7	11N8-70110	1	11N8-70010	1	11L1-2004	1	11L1-20031	1	-	
HL760-7A	11N8-70110	1	11LG-70010	1	11L1-2004	1	11L1-20031	1	-	
HL760-9	11N8-70110	1	11LC-70010	1	11Q8-20310	1	11Q8-20320	1	-	
HL770	11E1-70130	1	11E1-70220* ¹ 11E1-70240* ²	1 1	11L1-2004 14L1-01570* ⁵	1 1	11L1-20031 14L1-01560* ⁵	1 1	11E1-70320	1
HL770-7	11NA-70010	1	11NA-70010* ¹ 3800394* ²	1 1	14L1-01570	1	14L1-01560	1	11LB-70010	1
HL770-7A	11NA-70110	1	11LB-70020* ¹ 3973233* ²	1 1	14L1-01570	1	14L1-01560	1	11LB-70010	1

*¹Fuel filter

*²Fuel filter with water separator

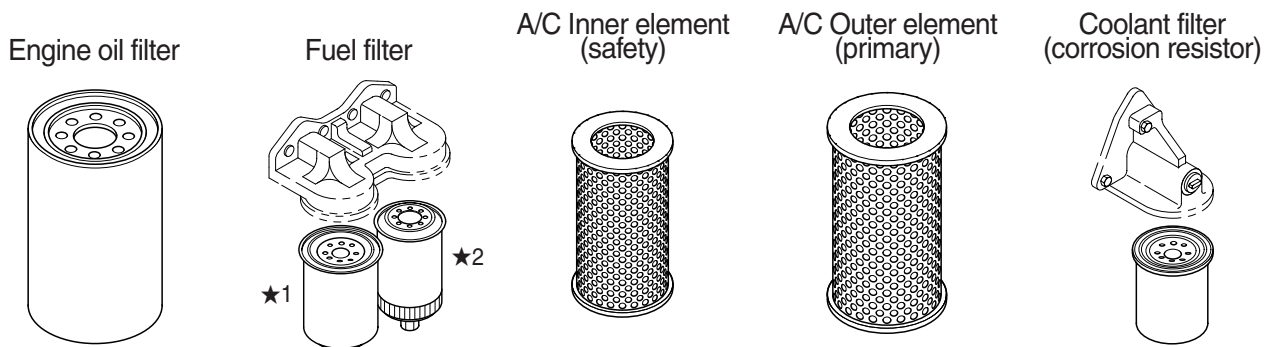

*Refer to page 8 for prefilter and fuel heater.

Wheel loader

Model	Engine oil filter		Fuel filter		A/C Inner element		A/C Outer element		Corrosion resistor	
	Part no.	Qty	Part no.	Qty	Part no.	Qty	Part no.	Qty	Part no.	Qty
HL770-9	11NA-70110	1	11LB-70020* ¹ 3973233* ²	1 1	11Q8-20120	1	11Q8-20130	1	3100307	1
HL780-3	11E1-70130	1	11E1-70220* ¹ 11E1-70240* ²	1 1	11L6-01050 11L6-01880-AS* ⁵	1 1	11L6-01040 11L6-01870-AS* ⁵	1 1	11E1-70320	1
HL780-3A	11NB-70110	1	11NB-70010	1	11L6-01880-AS	1	11L6-01870-AS	1	11NB-70210	1
HL780-7A	11NB-70110	1	11NB-70010	1	11L6-01880-AS #0448 11LQ-40120 #0449	1	11L6-01870-AS #0448 11LQ-40110 #0449	1	11NB-70210	1
HL780-9	3101869	1	3329289	1	11LQ-40120	1	11LQ-40110	1	3011308	1

*¹Fuel filter

*²Fuel filter with water separator

*⁵Low emission

Filters

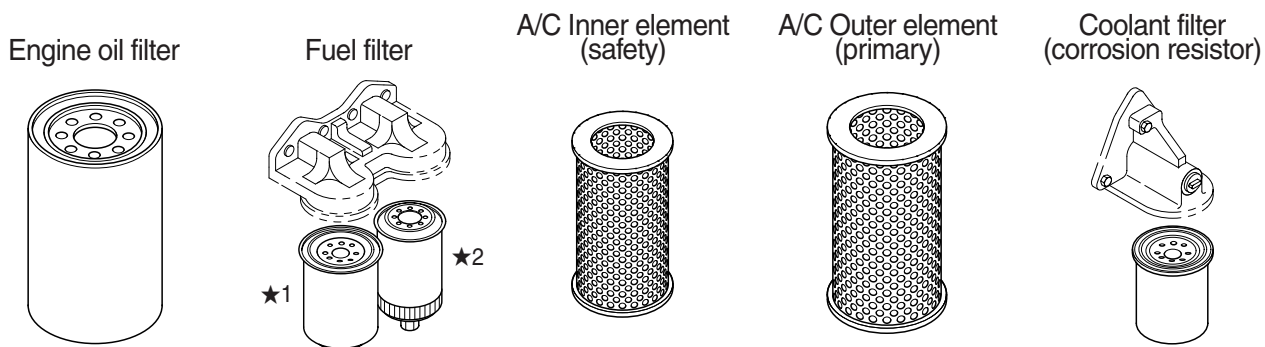

★ Refer to page 8 for prefilter and fuel heater.

Crawler Dozer

Model	Engine oil filter		Fuel filter		A/C Inner element		A/C Outer element		Corrosion resistor	
	Part no.	Qty	Part no.	Qty	Part no.	Qty	Part no.	Qty	Part no.	Qty
H70 H70LGP	11E1-70110	1	3931062	1	15D1-10230	1	15D1-10220	1	-	
H80 H80LGP	11E1-70110	1	15D1-06230	1	15D2-10110	1	15D2-10100	1	-	

Skid steer loader

Model	Engine oil filter		Fuel filter		A/C Inner element		A/C Outer element		Corrosion resistor	
	Part no.	Qty	Part no.	Qty	Part no.	Qty	Part no.	Qty	Part no.	Qty
HSL610	129150-35151	1	11M5-01620	1	11S1-20120 #0259 11S1-20121 #0260-	1	11S1-20110	1	-	
HSL650-7	16414-32430	1	16631-43560	1	11M8-20110	1	11M8-20120	1	-	
HSL650-7A	XJBR-00921	1	XJBR-01610	1	11M8-20110	1	11M8-20120	1	-	
HSL810	129150-35151	1	11M6-51070	1	11S1-20120 #0160 11S1-20121 #0161-	1	11S1-20110	1	-	
HSL850-7	1C020-32430	1	16631-43560	1	11S7-40130	1	11S7-40120	1	-	
HSL850-7A	XJBR-01534	1	XJBR-01610	1	11S7-40130	1	11S7-40120	1	-	

★ Additional prefilter & fuel heater

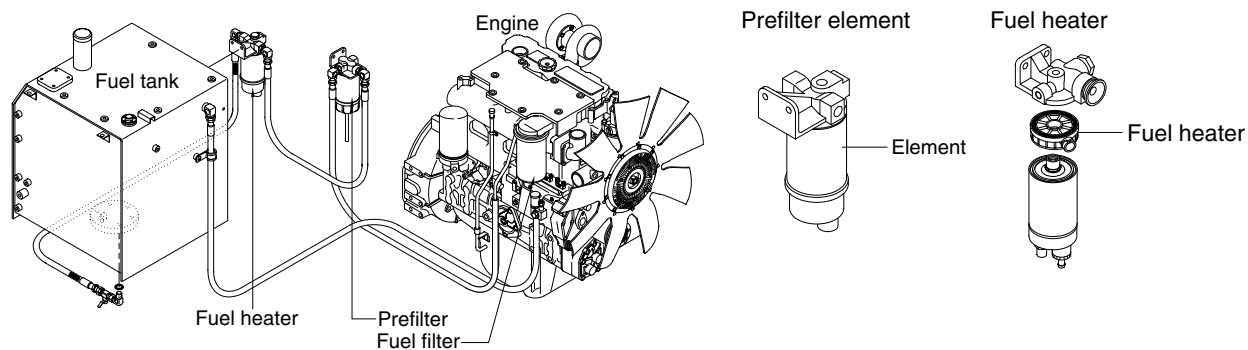

Item	Part no.	Applicable models
Prefilter element	11NA-71041	<ul style="list-style-type: none"> • 7A Series, Tier 3 engine - Excavator : R110 ~ R380LC-7A, R140W ~ R200W-7A - Wheel loader : HL730 ~ HL760-7A • 9 Series all models - Excavator : R110 ~ R380LC-9, R140W ~ R210W-9 - Wheel loader : HL730 ~ HL760-9
Fuel heater	11NA-71020	<ul style="list-style-type: none"> • Tier 3 7A/9 Series - Excavator : R110-7A ~ R380LC-9, R140W-7A ~ R210W-9 - Wheel loader : HL730-7A ~ HL760-9
	392702300	<ul style="list-style-type: none"> • R140LC-7 ~ R500LC-7, R450LC-7A, R480LC-9, R500LC-7A, R520LC-9, R140W-7, R200W-7, HL770-7A, HL770-9, HL780-7A, HL780-9

※ Please refer to parts manual for machine serial number.

Pilot line filter element

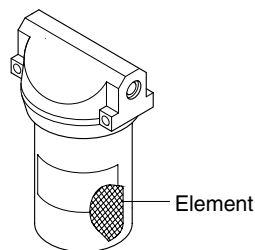

Return filter element

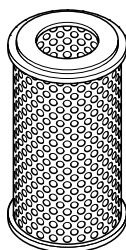

Drain filter



Air breather element

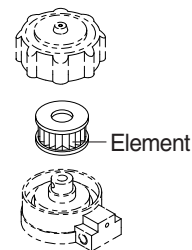

Hydraulic excavator

Model	Pilot line filter element		Return filter element		Drain filter		Air breather element		
	Part no.	Qty	Part no.	Qty	Part no.	Qty	Part no.	Qty	
R16-9	31MH-20320	1	31MJ-01300	1	-		-		
R27Z-9	31MH-20320	1	31MH-01310	1	-		-		
R35Z-7	31MH-20320	1	31MH-01310	1	-		-		
R35Z-7A	31MH-20320	1	31MH-01310	1	-		-		
R35Z-9	31MH-20320	1	31MH-01310	1	-		-		
R55-3	31E3-0017 31E3-0018	#0616 #0617-	31EE-01060	1	-		31E1-10380 31EE-02010 31EE-02110	#1267 #1268-1350 #1351-	1
R55-7	31E3-0018	1	31EE-01060	1	-		31EE-02110		1
R55-9	31MH-20320	1	31MH-01310	1	-		31EE-02110		1
R55-7A	31MH-20320	1	31MH-01310	1	-		31EE-02110		1
R55W-9	31MH-20320	1	31MH-01310	1	-		31EE-02110		1
R80-7	-	-	31EE-01060	1	-		31EE-02110		1
R80-7A	31MH-20320	1	31MH-01310	1	-		31EE-02110		1
R110-7	31E3-0018	1	E131-0212	1	31E9-0126	1	31EE-02110		1
R110-7A	31MH-20320	1	E131-0212	1	31E9-0126	1	31EE-02110		1
R130LC	31E3-0018	1	31E3-4527	1	31E9-0126	1	31E1-10380		1
R130LC-3	31E3-0018	1	31E3-4527	1	31E9-0126	1	31E1-10380 31EE-02110	#1933 #1934-	1
R140LC-7	31E3-0018	1	E131-0212	1	31E9-0126	1	31EE-02010 31EE-02110	#1014 #1015-	1
R140LC-7A	31MH-20320	1	31N4-01460	1	31N8-01360	1	31EE-02110		1
R140LC-9	ZGAW-00013	1	31N4-01460	1	31N8-01360	1	31EE-02110		1
R145CR-9	ZGAW-00013	1	31N4-01460	1	31N8-01360	1	31EE-02110		1
R160LC-3	31E3-0018	1	31E3-4527	1	31E9-0126	1	31EE-02010 31EE-02110	#0505 #0506-	1
R160LC-7	31E3-0018	1	E131-0212	1	31E9-0126	1	31EE-02110		1
R160LC-7A	31MH-20320	1	31N4-01460	1	31N8-01360	1	31EE-02110		1
R160LC-9	ZGAW-00013	1	31N4-01460	1	31N8-01360	1	31EE-02110		1
R180LC-3	31E3-0018	1	31E9-1019	1	31E9-0126	1	31E1-10380 31EE-02110	#0647 #0648-	1
R180LC-7	31E3-0018	1	E131-0212	1	31E9-0126	1	31EE-02110		1
R180LC-7A	31MH-20320	1	31N4-01460	1	31N8-01360	1	31EE-02110		1
R180LC-9	ZGAW-00013	1	31N4-01460	1	31N8-01360	1	31EE-02110		1
R200LC	31E3-0018	1	E131-0212	1	-		31E1-10380		1
R200NLC-3	31E3-0018	1	31E9-1019	1	31E9-0126	1	31E1-10380 31EE-02110	#0053 #0054-	1
R210LC-3/LL 33HDLL	31E3-0018	1	E131-0212	1	31E9-0126	1	31E1-10380		1
R210LC-3H	31E3-0018	1	E131-0212	1	31E9-0126	1	31E1-10380 31EE-02110	#0435 #0436-	1
R210LC-7	31E3-0018	1	E131-0212	1	31E9-0126	1	31EE-02010 31EE-02110	#1049 #1050-	1

Pilot line filter element

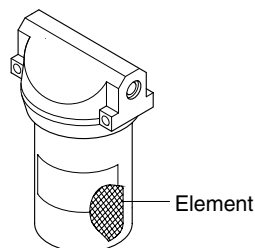

Return filter element

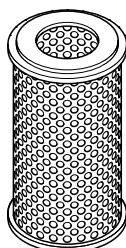

Drain filter



Air breather element

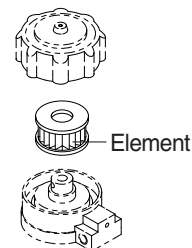

Hydraulic excavator

Model	Pilot line filter element		Return filter element		Drain filter		Air breather element	
	Part no.	Qty	Part no.	Qty	Part no.	Qty	Part no.	Qty
R210LC-7A	31MH-20320	1	31N4-01460	1	31N8-01360	1	31EE-02110	1
R210LC-7H R210NLC-7	31E3-0018	1	E131-0212	1	31E9-0126		31EE-02110	1
R210NLC-7A	31MH-20320	1	31N4-01460	1	31N8-01360	1	31EE-02110	1
R210LC-9	ZGAW-00013	1	31Q6-01280	1	31N8-01360	1	31EE-02110	1
R210NLC-9	ZGAW-00013	1	31N4-01460	1	31N8-01360	1	31EE-02110	1
R235LCR-9	ZGAW-00013	1	31Q6-01280	1	31N8-01360	1	31EE-02110	1
R250LC-3	31E3-0018	1	E131-0212	1	31E9-0126	1	31E1-10380	1
R250LC-7	31E3-0018	1	E131-0212	1	31E9-0126	1	31EH-00480	1
R250LC-7A	31MH-20320	1	31N4-01460	1	31N8-01360	1	31EH-00480	1
R250LC-9	ZGAW-00013	1	31N4-01460	1	31N8-01360	1	31EE-02110	1
R280LC	31E3-0018	1	E131-0212	2	-		31E1-10380	1
R290LC	31E3-0018	1	31E9-1019	2	31E9-0126	1	31E1-10380	1
R290LC-3 R290LC-3LL/RB	31E3-0018	1	31E9-1019	2	31E9-0126	1	31E1-10380	1
42HDLL 39HDRB	31E3-0018	1	31E9-1019	2	31E9-0126	1	31E1-10380	1
R290LC-7	31E3-0018	1	31E9-1019	2	31E9-0126	1	31EE-02010 31EH-00480	#0029 #0030- 1
R290LC-7A	31E3-0018 31MH-20320	#0284 #0285- 1	31E9-1019 31N8-01510	#0284 #0285- 2	31E9-0126 31N8-01360	#0284 #0285- 1	31EH-00480	1
R290LC-7H	31E3-0018	1	31E9-1019	2	31E9-0126	1	31EH-00480	1
R290LC-9	ZGAW-00013	1	31N4-01460	2	31N8-01360	1	31EH-00480	1
R305LC-7	31E3-0018	1	31E9-1019	2	31E9-0126	1	31EH-00480	1
R320LC R320LC-3	31E3-0018	1	31E9-1019	2	31E9-0126	1	31E1-10380	1
R320LC-7	31E3-0018	1	31E9-1019	2	31E9-0126	1	31EH-00480	1
R320LC-7A	31E3-0018 31MH-20320	#0151 #0152- 1	31E9-1019 31N8-01510	#0151 #0152- 2	31E9-0126 31N8-01360	#0151 #0152- 1	31EH-00480	1
R360LC-3 R360LC-3H	31E3-0018	1	31E9-1019	2	31E9-0126	1	31EH-00480	1
R320LC-9	ZGAW-00013	1	31N4-01460	2	31N8-01360	1	31EH-00480	1
R360LC-7	31E3-0018	1	31E9-1019	2	31E9-0126	1	31EH-00480	1
R360LC-7A	31E3-0018 31MH-20320	#0077 #0078- 1	31E9-1019 31N8-01510	#0077 #0078- 2	31E9-0126 31N8-01360	#0077 #0078- 1	31EH-00480	1
R380LC-9	ZGAW-00013	1	31N8-01510	2	31N8-01360	1	31EH-00480	1
R450LC	Y-2481	1	070-630-1142	2	-		31E7-4303 31E7-0377	#0564 #0565- 1
R450LC-3	31E3-0018	1	34E7-02310	2	34E7-04170	#1084- 1	31EH-00480	1
R450LC-7	31E3-0018	1	31E9-1019	1	34E7-04170 31E9-0126	#0395 #0396- 1	31EH-00480	1
R450LC-7A	31E3-0018 31MH-20320	#0125 #0126- 1	31E9-1019 31N8-01510	#0125 #0126- 1	31E9-0126 31N8-01360	#0125 #0126- 1	31EH-00480	1

Pilot line filter element

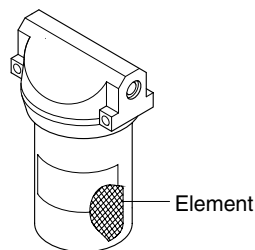

Return filter element

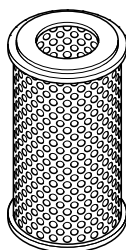

Drain filter



Air breather element

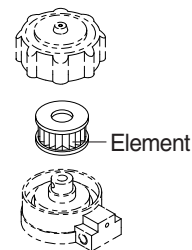

Hydraulic excavator

Model	Pilot line filter element		Return filter element		Drain filter		Air breather element	
	Part no.	Qty	Part no.	Qty	Part no.	Qty	Part no.	Qty
R480LC-9	ZGAW-00013	1	31N8-01510	2	31N8-01360	1	31EH-00480	1
R500LC-7	31E3-0018	1	31E9-1019	2	31E9-0126	1	31EH-00480	1
R500LC-7A	31E3-0018 31MH-20320	-#0062 #0063- 1	31E9-1019 31N8-01510	-#0062 #0063- 2	31E9-0126 31N8-01360	-#0062 #0063- 1	31EH-00480	1
R520LC-9	ZGAW-00013	1	31N8-01510	2	31N8-01360	#0063- 1	31EH-00480	1
R800LC-7A	31MH-20320	1	31N4-01460	3	31ND-01460	2	31EH-00480	1
R55W-3	31E3-0018	1	31EE-01060	1	-		31E1-10380 31EE-02010 31EE-02110	-#0188 #0189-0211 #0212- 1
R55W-7	31E3-0018	1	31EE-01060	1	-		31EE-02110	1
R55W-7A	31E3-0018	1	31MH-01310	1	-		31EE-02110	1
R55W-9	31MH-20320	1	31MH-01310	1	-		31EE-02110	1
R95W-3	31E3-0018	1	31EE-01060	1	-		31EE-02010	1
R120W	31E3-0018	1	31E3-4527	1	-		31E1-10380	1
R130W	31E3-0018	1	31E3-4527	1	31E9-0126	1	31E1-10380	1
R130W-3	31E3-0018	1	31E3-4527	1	31E9-0126	1	31EE-02010	1
R140W-7	31E3-0018	1	E131-0212	1	31E9-0126	1	31EE-02110	1
R140W-7A	31MH-20320	1	31N4-01460	1	31N8-01360	1	31EE-02110	1
R140W-9	ZGAW-00013	1	31N4-01460	1	31N8-01360	1	31EE-02110	1
R170W-3	31E3-0018	1	31E9-1019	1	31E9-0126	1	31E1-10380 31EE-02110	-#0431 #0432- 1
R170W-7	31E3-0018	1	E131-0212	1	31E9-0126	1	31EE-02110	1
R170W-7A	31MH-20320	1	31N4-01460	1	31N8-01360	1	31EE-02110	1
R170W-9	ZGAW-00013	1	31N4-01460	1	31N8-01360	1	31EE-02110	1
R200W	31E3-0018	1	E131-0212	1	-		31E1-10380	1
R200W-3	31E3-0018	1	E131-0212	1	31E9-0126	1	31EE-02010 31EE-02110	-#0231 #0232- 1
R200W-7	31E3-0018	1	E131-0212	1	31E9-0126	1	31EE-02110 31EH-00480	-#1260 #1261- 1
R200W-7A	31MH-20320	1	31N4-01460	1	31N8-01360	1	31EE-02110 31EH-00480	-#0033 #0034- 1
R210W-9	ZGAW-00013	1	31N4-01460	1	31N8-01360	1	31EE-02110	1

Pilot line filter element

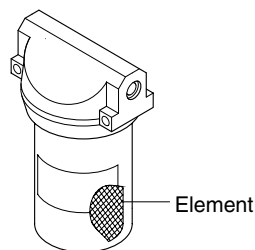

Return filter element

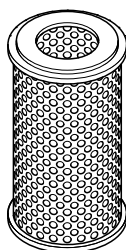

Drain filter

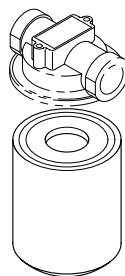

Air breather element

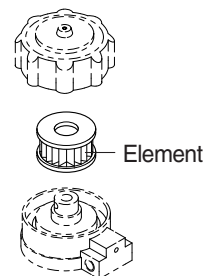

Wheel loader

Model	Pilot line filter element		Return filter element		Drain filter		Air breather element	
	Part no.	Qty	Part no.	Qty	Part no.	Qty	Part no.	Qty
HL17/25/35	31E3-0018	1	31L1-4041	1	-		31E1-10380	1
HL720-3	31E3-0018	1	31L9-60161	1	-		31E1-10380	1
HL730-3 HL730TM-3	31E3-0018	1	34L3-00341	1	-		31E1-10380	1
HL730-7	31E3-0018	1	31L9-60161 31L1-4041*1	1	-		31EE-02110	1
				#0057-				
HL730TM-7	31E3-0018	1	31L9-60161 31L1-4041*1	1	-		31EE-02110	1
				#0010-				
HL730-7A HL730TM-7A	31MH-20320	1	31LH-60070	1	-		31EE-02110	1
HL730-9 HL730TM-9	31LM-10310	1	31LH-60070	1	-		31EE-02110	1
HL740-3 HL740TM-3	31E3-0018	1	34L3-00340 34L3-00341	1	-		31E1-10380	1
				-#0012 #0013-				
HL740-7 HL740TM-7	31E3-0018	1	31L1-4041	1	-		31EE-02110	1
HL740-7A HL740TM-7A	31MH-20320	1	31LH-60070	1	-		31EE-02110	1
HL740-9 HL740TM-9	31LM-10310	1	31LH-60070	1	-		31EE-02110	1
HL750	31E3-0018	1	34L3-00340 34L3-00341	1	-		31E1-10380	1
				-#1000 #1001-				
HL750TM	31E3-0018	1	34L3-00341	1	-		31E1-10380	1
HL757-7 HL757TM-7	31E3-0018	1	34L3-00341	1	-		31EE-02110	1
HL757-7A	31E3-0018 31MH-20320	-#0017 #0018-	31LD-60290 31LD-60070	-#0017 #0018-	-		31EE-02110	1
HL757TM-7A	31MH-20320	#0001-	31LD-60070		-		31EE-02110	1
HL757-9 HL757TM-9	31LM-10310		31LD-60070		-		31EE-02110	1
HL760	31E3-0018	1	31L1-4041	1	-		31E1-10380	1
HL760-7	31E3-0018	1	31L1-4041	1	-		31EE-02110	1
HL760-7A	31E3-0018 31MH-20320	-#0212 #0213-	31L1-4041 31LH-60070	-#0186 #0187-	-		31EE-02110	1
HL760-9	31LM-10310		31N8-01510		-		31EE-02110	1
HL770	31E3-0018	1	31L1-4041	1	-		31E1-10380	1
HL770-7	31E3-0018	1	31L1-4041	1	-		31EH-00480	1
HL770-7A	31E3-0018 31MH-20320	-#0262 #0263-	31L1-4041 31LH-60070	-#0262 #0263-	-		31EH-00480	1
HL770-9	31LM-10310		31N4-01460		-		31EH-00480	1
HL780-3	31E3-0018	1	31L1-4041	1	-		31E1-10380	1
HL780-3A	31E3-0018	1	31L1-4041	1	-		31EH-00480	1
HL780-7A	31E3-0018 31MH-20320	-#0145 #0146-	31L1-4041 31LH-60070 31LD-60070	-#0145 #0146-0407 #0408-	-		31EH-00480	1
HL780-9	31LM-10310		31LD-60070		-		31EH-00480	1

*1Round cowl type

Pilot line filter element

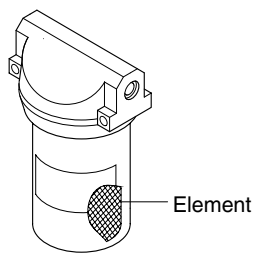

Return filter element

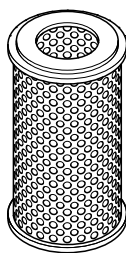

Drain filter

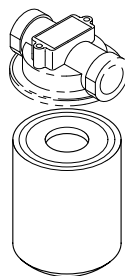

Air breather element

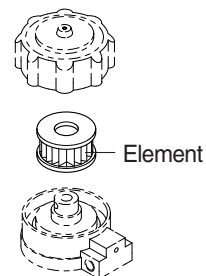

Crawler Dozer

Model	Pilot line filter element		Return filter element		Drain filter		Air breather element	
	Part no.	Qty	Part no.	Qty	Part no.	Qty	Part no.	Qty
H70 H70LGP	-		35D1-00630	1	-		31E1-10380	1
H80 H80LGP	-		35D1-00630	1	-		31E1-10380	1

Skid steer loader

Model	Pilot line filter element		Return filter element		Drain filter		Air breather element	
	Part no.	Qty	Part no.	Qty	Part no.	Qty	Part no.	Qty
HSL610	-		31S1-1013	1	-		-	
HSL650-7	-		31S8-40040 31S7-00170	1	-		-	
HSL650-7A	-		31S7-00170	1	-		-	
HSL810	-		31S5-00210	1	-		-	
HSL850-7	-		31FA-60071 31FA-60070 31S7-00170	1	-		-	
HSL850-7A	-		31S7-00170	1	-		-	

Transmission oil filter element

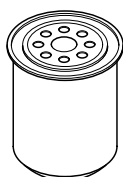

Air conditioner filter

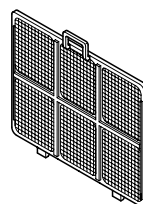

Inner

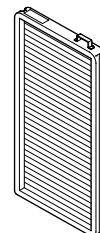

Outer

Hydraulic excavator

Model	Transmission oil filter element		Air conditioner filter-inner		Air conditioner filter-outer			
	Part no.	Qty	Part no.	Qty	Part no.	Qty		
R27Z-9	-		-		11MH-90330*1	1		
R35Z-7	-		11MH-90330 #0005-	1	-			
R35Z-7A	-		11MH-90330	1	-			
R35Z-9	-		-		11MH-90330*1	1		
R55-7	-		11M8-90170 #2797 11M8-90171 #2798-	1	-			
R55-7A	-		11M8-90171	1	-			
R55-9	-		XKAN-00030	2	11M9-90370	1		
R80-7	-		11N6-90770	1	11N6-90760	1		
R80-7A	-		11N6-90770	1	11N6-90760	1		
R110-7	-		11N6-90770	1	11N6-90760	1		
R110-7A	-		11N6-90770	1	11N6-90760	1		
R130LC-3	-		AM88000300-2	1	AM880001002 #0927 AM88000200-2 #0928-	1		
R140LC-7	-		11N6-90770	1	11N6-90760	1		
R140LC-7A	-		11N6-90770	1	11N6-90760	1		
R140LC-9	-		11N6-90770	1	11Q6-90510	1		
R145CR-9	-		XKAN-00030	2	31M9-90370	1		
R160LC-3	-		AM88000300-2	1	AM88000200-2	1		
R160LC-7	-		11N6-90770	1	11N6-90760	1		
R160LC-7A	-		11N6-90770	1	11N6-90760	1		
R160LC-9	-		11N6-90770	1	11Q6-90510	1		
R180LC-3	-		AM88000300-2	1	AM88000200-2	1		
R180LC-7	-		11N6-90770	1	11N6-90760	1		
R180LC-7A	-		11N6-90770	1	11N6-90760	1		
R180LC-9	-		11N6-90770	1	11Q6-90510	1		
R210LC-3 R210LC-3LL	-		AM88000300-2	1	AM880001002 #0276 AM88000200-2 #0277-	1		
33HDLL	-		AM88000300-2	1	AM88000200-2	1		
R210LC-7	-		11N6-90770	1	11N6-90760	1		
R210LC-7A	-		11N6-90770	1	11N6-90760	1		
R210LC-7H	-		11N6-90770	1	11N6-90760	1		
R210LC-9	-		11N6-90770	1	11Q6-90510	1		
R210NLC-7	-		11N6-90770	1	11N6-90760	1		
R210NLC-7A	-		11N6-90770	1	11N6-90760	1		
R210NLC-9	-		11N6-90770	1	11Q6-90510	1		

*1 Heater filter

Transmission oil filter element

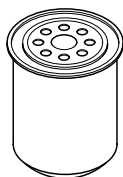

Air conditioner filter

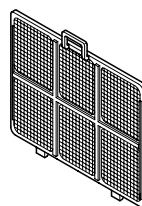

Inner

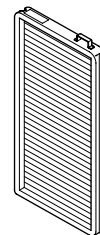

Outer

Hydraulic excavator

Model	Transmission oil filter element		Air conditioner filter-inner		Air conditioner filter-outer			
	Part no.	Qty	Part no.	Qty	Part no.	Qty		
R235LCR-9	-		XKAN-00030	2	11M9-90370	1		
R250LC-3	-		AM88000300-2	1	AM88000200-2	1		
R250LC-7	-		11N6-90770	1	11N6-90760	1		
R250LC-7A	-		11N6-90770	1	11N6-90760	1		
R250LC-9	-		11N6-90770	1	11Q6-90510	1		
R290LC-3	-		AM88000300-2	1	AM880001002	-#0551 #0552-	1	
R290LC-3LL/RB	-		AM88000300-2	1	AM88000200-2			
42HDLL	-		AM88000300-2	1	AM88000200-2			
39HDRB	-		AM88000300-2	1	AM88000200-2			
R290LC-7	-		11N6-90770	1	11N6-90760	1		
R290LC-7A	-		11N6-90770	1	11N6-90760	1		
R290LC-7H	-		11N6-90770	1	11N6-90760	1		
R290LC-9	-		11N6-90770	1	11Q6-90510	1		
R305LC-7	-		11N6-90770	1	11N6-90760	1		
R320LC-3	-		AM88000300-2	1	AM88000300-2	1		
R320LC-7	-		11N6-90770	1	11N6-90760	1		
R320LC-7A	-		11N6-90770	1	11N6-90770	1		
R320LC-9	-		11N6-90770	1	11Q6-90510	1		
R360LC-3	-		AM88000300-2	1	AM880001002	-#0036 #0037-	1	
R360LC-7	-		11N6-90770	1	11N6-90760			
R360LC-7A	-		11N6-90770	1	11N6-90760	1		
R380LC-9	-		11N6-90770	1	11Q6-90510	1		
R450LC-3	-		AM88000300-2	1	AM880001002	-#0145 #0146-	1	
R450LC-7	-		11N6-90770	1	11N6-90760			
R450LC-7A	-		11N6-90770	1	11N6-90760	1		
R480LC-9	-		11N6-90770	1	11Q6-90510	1		
R500LC-7	-		11N6-90770	1	11N6-90760	1		
R500LC-7A	-		11N6-90770	1	11N6-90760	1		
R520LC-9	-		11N6-90770	1	11Q6-90510	1		
R800LC-7A	-		11N6-90770	1	11N6-90760	1		
R55W-7	-		11M8-90170	-#0632 #0633-	-			
	-		11M8-90171		1			
R55W-7A	-		11M8-90171	1	-			
R55W-9	-		XKAN-00030	2	11M9-90370	1		
R95W-3	0501-210-564	1	-		-			
R130W-3	-		AM88000300-2	1	AM88000200-2	1		
R140W-7	ZGAQ-01063	1	11N6-90770	1	11N6-90760	1		

Transmission oil filter element

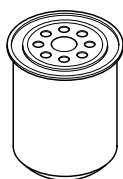

Air conditioner filter

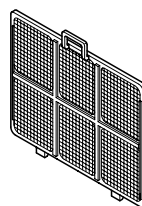

Inner

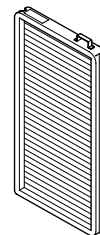

Outer

Hydraulic excavator

Model	Transmission oil filter element		Air conditioner filter-inner		Air conditioner filter-outer			
	Part no.	Qty	Part no.	Qty	Part no.	Qty		
R140W-7A	ZGAQ-01063	1	11N6-90770	1	11N6-90760	1		
R140W-9	ZGAQ-01063	1	11N6-90770	1	11Q6-90510	1		
R170W-3	0501-210-564	1	AM88000300-2	1	AM88000200-2	1		
R170W-7	ZGAQ-01063	1	11N6-90770	1	11N6-90760	1		
R170W-7A	ZGAQ-01063	1	11N6-90770	1	11N6-90760	1		
R170W-9	ZGAQ-01063	1	11N6-90770	1	11Q6-90510	1		
R200W-3	0501-210-564	1	AM88000300-2	1	AM88000200-2	1		
R200W-7	ZGAQ-01063	1	11N6-90770	1	11N6-90760	1		
R200W-7A	ZGAQ-01063	1	11N6-90770	1	11N6-90760	1		
R210W-9	ZGAQ-01063	1	11N6-90770	1	11Q6-90510	1		

Transmission oil filter element



Air conditioner filter

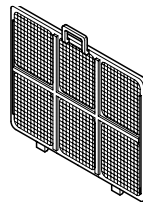

Inner

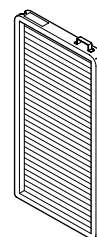

Outer

Wheel loader

Model	Transmission oil filter element		Air conditioner filter-inner		Air conditioner filter-outer			
	Part no.	Qty	Part no.	Qty	Part no.	Qty		
HL17	247052	1	-		-			
HL25	0750-131-033	1	-		-			
HL35	0501-208-244	1	-		-			
HL720-3	0750-131-029	1	AM88000300-2	1	74L3-04560	1		
HL730-3 HL730TM-3	0750-131-060	1	AM88000300-2	1	74L3-04560	1		
HL730-7	ZGAQ-00001 ZGAQ-02400	<small>-#0412 #0413-</small> 1	11N6-90770	1	71LB-00290	1		
HL730TM-7	ZGAQ-00001 ZGAQ-02400	<small>-#0134 #0135-</small> 1	11N6-90770	1	71LB-00290	1		
HL730-7A HL730TM-7A	ZGAQ-02400	1	11N6-90770	1	71LB-00290	1		
HL730-9 HL730TM-9	ZGAQ-02400	1	11N6-90770	1	71LB-00290	1		
HL740-3	247052 0750-131-060	<small>-#0847 #0848-</small> 1	AM88000300-2	1	74L3-04560	1		
HL740TM-3	247052 0750-131-060	<small>-#0250 #0251-</small> 1	AM88000300-2	1	74L3-04560	1		
HL740-7	ZGAQ-00001 ZGAQ-02400	<small>-#1398 #1399-</small> 1	11N6-90770	1	71LB-00290	1		
HL740TM-7	ZGAQ-00001 ZGAQ-02400	<small>-#0432 #0433-</small> 1	11N6-90770	1	71LB-00290	1		
HL740-7A HL740TM-7A	ZGAQ-02400	1	11N6-90770	1	71LB-00290	1		
HL740-9 HL740TM-9	ZGAQ-02400	1	11N6-90770	1	71LB-00290	1		
HL750 HL750TM	247052	1	AM88000300-2	1	74L3-04560	1		
HL757-7	ZGAQ-00001 ZGAQ-02400	<small>-#1425 #1426-</small> 1	11N6-90770	1	71LB-00290	1		
HL757TM-7	ZGAQ-00001 ZGAQ-02400	<small>-#0116 #0117-</small> 1	11N6-90770	1	71LB-00290	1		
HL757-7A HL757TM-7A	ZGAQ-02400	1	11N6-90770	1	71LB-00290	1		
HL757-9 HL757TM-9	ZGAQ-02400	1	11N6-90770	1	71LB-00290	1		
HL760	0750-131-053* ¹ 0750-131-060* ¹ 0750-131-061	<small>-#18423 -#18424-1301 #1302-</small> 1	AM88000300-2	1	74L3-04560	1		
HL760-7	ZGAQ-00001	1	11N6-90770	1	71LB-00290	1		
HL760-7A	ZGAQ-02400	1	11N6-90770	1	71LB-00290	1		
HL760-9	ZGAQ-02400	1	11N6-90770	1	71LB-00290	1		
HL770	0750-131-035 0750-131-063	<small>-#1170 #1171-</small> 1	AM88000300-2	1	74L3-04560	1		
HL770-7	ZGAQ-00001	1	11N6-90770	1	74L3-04560 71LB-00290	<small>-#0003 #0004-</small> 1		
HL770-7A	ZGAQ-02400	1	11N6-90770	1	71LB-00290	1		
HL770-9	ZGAQ-02400	1	11N6-90770	1	71LB-00290	1		

*¹Transmission serial No.

Transmission oil filter element

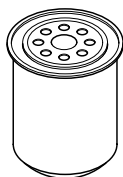

Air conditioner filter

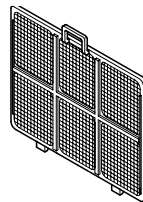

Inner

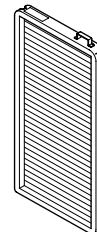

Outer

Wheel loader

Model	Transmission oil filter element		Air conditioner filter-inner		Air conditioner filter-outer			
	Part no.	Qty	Part no.	Qty	Part no.	Qty		
HL780-3	243622	1	AM88000300-2	1	74L3-04560	1		
HL780-3A	ZGAQ-00001	1	AM88000300-2	1	74L3-04560	1		
HL780-7A	ZGAQ-02400	1	11N6-90770	1	71LB-00290	1		
HL780-9	ZGAQ-02400	1	11N6-90770	1	71LB-00290	1		

Crawler Dozer

Model	Pilot line filter element		Return filter element		Drain filter			
	Part no.	Qty	Part no.	Qty	Part no.	Qty		
H70 H70LGP	85D1-10200	1	-		-			
H80 H80LGP	85D2-20030	1	-		-			